

Fiber Media Converter

WI-MC101M | WI-MC103G | WI-MC101G |
WI-MC111G | WI-MC111GP|WI-MC111GP-O



Overview

Wi-Tek's media converters are designed to convert between 100M Ethernet RJ45port and fiber port, and 1000M Ethernet RJ45 port and fiber port. Carrying out long-distance data and video signal transmission via optical fiber, Wi-Tek's media converters facilitates the convenience of network upgrade and flow control. With ultra-low transmission delay and line speed forwarding ability, they can realize flexible Ethernet expansion even in harsh environment.

Features

Supports 100Mbps and 1000Mbps data transfer rates to meet a range of requirements.

Support full-duplex and half-duplex transmission mode.
(For WI-MC101M,WI-MC103G,WI-MC101G,WI-MC111G, WI-MC111GP)

Equipping with high-performance chip to ensure stable network.

Powerful heat dissipation function with double-side ventilation design.

Support 802.3af/at PoE Out, which enables the port to carry out data and power via one Ethernet cable at the same time and makes deployment more flexible.
(For WI-MC111GP,WI-MC111GP-O)

IP65 Weatherproof Enclosure

Built to withstand harsh outdoor conditions with an IP65-rated weatherproof housing, ensuring reliable operation in various environments.
(For WI-MC111GP-O)

Specifications



Model	WI-MC101M	WI-MC103G	WI-MC101G
Interface	1*100Mbps SC Port 1*100Mbps Ethernet RJ45	1*1000Mbps SC Port 1*1000Mbps Ethernet RJ45 Port	1*1000Mbps SC Port 1*1000Mbps Ethernet RJ45 Port
Wave Length	1310nm /1550nm		
Transmission Media	Single-mode Fiber		
Transmission Distance	20km	3km	20km
Max Power Consumption	2.5W	3W	3.3W
Power Supply	DC-IN 5V/1A	DC-IN 5V/1A	DC-IN 5V/1A
Indicators	<p>FX 100M (Optical Link) Solid on: Optical Link On Off: Optical Link Down</p> <p>TX 100M (Network Link) Solid on: Link Connected Flash: Data Transmission Off: Link Disconnected</p> <p>FX Link (Optical data) Solid on: Optical Link Connected Flash: Data Transmission Off: Optical Link Disconnected</p> <p>TX Link (Network data) Solid on: Link Connected Flash: Data Transmission Off: Link Disconnected</p> <p>PWR (Power indicator) Solid on: the device power on is</p>	<p>1000M (1000M Network Link) Solid on: 1000M Network Link</p> <p>100M (100M Network data) 100M Network Link</p> <p>FX (Optical Link&Act) Solid on: Optical Link Connected Flash: Data Transmission Off: Optical Link Disconnected</p> <p>Link (Network Link&Act) Solid on: Link Connected Flash: Data Transmission Off: Link Disconnected</p> <p>PWR (Power indicator) Solid on: the device power on is normal Off: the device is power off or failed</p> <p>FDX (Network mode) Solid on: Full-Duplex Off: Half-Duplex</p>	

Indicators	<p>normal</p> <p>Off: the device is power off or failed</p> <p>FDX (Network mode)</p> <p>Solid on: Full-Duplex</p> <p>Off: Half-Duplex</p>		
Dimensions	<p>Product Dimension: 96*70*27mm</p> <p>Package Dimension: 243*191*59mm</p>	<p>Product Dimension: 96*70*27mm</p> <p>Package Dimension: 243*191*59mm</p>	<p>Product Dimension: 96*70*27mm</p> <p>Package Dimension: 243*191*59mm</p>
Weight	<p>Net Weight: 0.19*2kg</p> <p>Gross Weight: 0.78kg</p>	<p>Net Weight: 0.19*2kg</p> <p>Gross Weight: 0.75kg</p>	<p>Net Weight: 0.19*2kg</p> <p>Gross Weight: 0.77kg</p>
Environment	<p>Operating Temperature: -20°C ~ 50°C (-4°F ~ 122°F)</p> <p>Storage Temperature: -40°C ~ 70°C(-40°F ~ 158°F)</p> <p>Operating Humidity: 10% ~ 90%(non-condensing)</p> <p>Storage Humidity: 5% ~ 95% (non-condensing)</p>		
Certification	<p>CE, FCC, RoHS, UKCA, RCM</p>		



Model	WI-MC111G	WI-MC111GP	WI-MC111GP-O
Interface	1*1000Mbps SFP Slot 1*1000Mbps Ethernet RJ45 Port	1*1000Mbps SFP Port 1*1000Mbps RJ-45 Port with 802.3af/at PoE Out	1*1000Mbps SFP Port 1*1000Mbps RJ-45 Port with 802.3af/at PoE Out
Wave Length	Depend on used SFP module		
Transmission Media	Single-mode Fiber or Multi-mode Fiber		
Transmission Distance	Depends on the inserting SFP module		
Max Power Consumption	3.5W	3W	3W
Power Supply	DC-IN 5V/1A	DC-IN 48-52V/0.92A	DC-IN 44-57V
Indicators	<p>1000M (1000M Network Link) Solid on: 1000M Network Link</p> <p>100M (100M Network data) 100M Network Link</p> <p>FX (Optical Link&Act) Solid on: Optical Link Connected Flash: Data Transmission Off: Optical Link Disconnected</p> <p>Link (Network Link&Act) Solid on: Link Connected Flash: Data Transmission Off: Link Disconnected</p> <p>PWR (Power indicator) Solid on: the device power on is normal Off: the device is power off or failed</p> <p>FDX (Network mode) Solid on: Full-Duplex Off: Half-Duplex</p>		

Dimensions	Product Dimension: 99*70*27mm Package Dimension: 207*161*55mm	Product Dimension: 99*70*27mm Package Dimension: 207*161*55mm	Product Dimension: 160*83*44mm Package Dimension: 195*98*65mm
Weight	Net Weight: 0.2kg Gross Weight: 0.40kg	Net Weight: 0.2kg Gross Weight: 0.45kg	Net Weight: 0.16kg Gross Weight: 0.24kg
Environment	Operating Temperature: -20°C ~ 50°C (-4°F ~ 122°F) Storage Temperature: -40°C ~ 70°C (-40°F ~ 158°F) Operating Humidity: 10% ~ 90%(non-condensing) Storage Humidity: 5% ~ 95% (non-condensing)		Operating Temperature: 0~40°C (32~104°F) Storage Temperature: -40~70°C (-40~158°F) Operating Humidity : 10%~90%, non-condensing Storage Temperature: 5%~95%, non-condensing
Certification	CE, FCC, RoHS, UKCA, RCM		

WI-MC101M

Dimensions (mm)

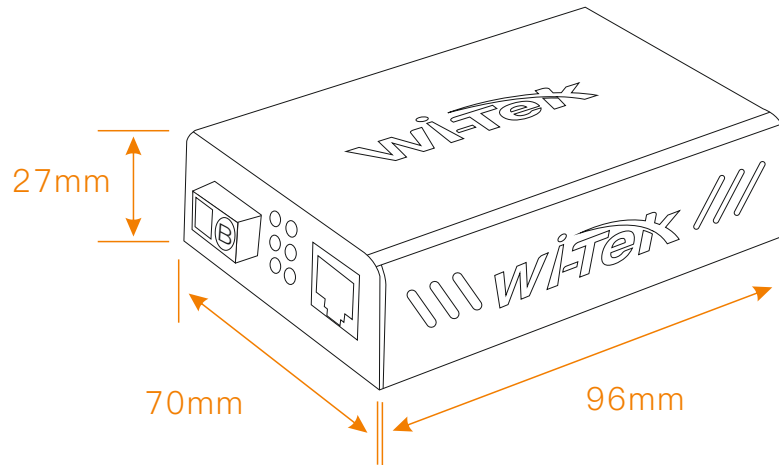

Front Panel

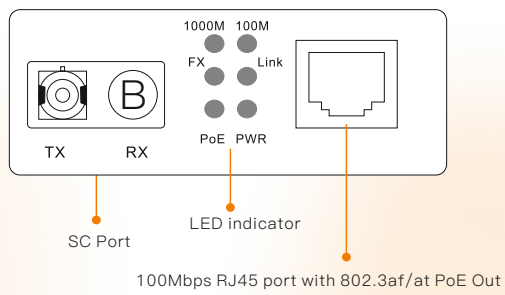

Rear Panel

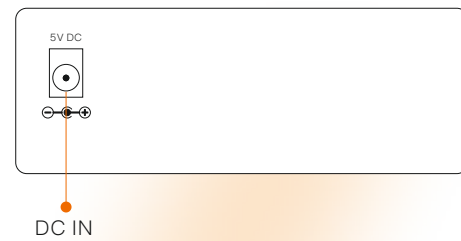

WI-MC103G

Dimensions (mm)

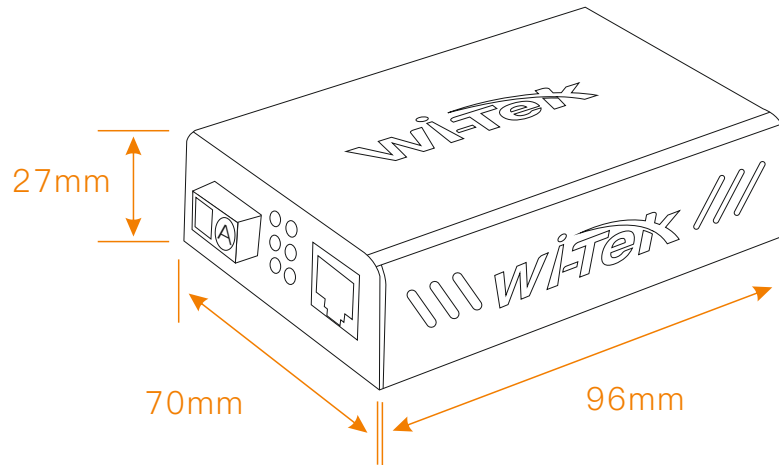

Front Panel

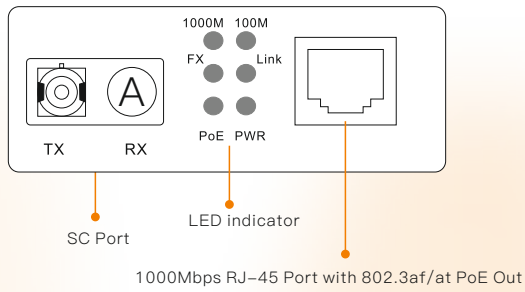

Rear Panel

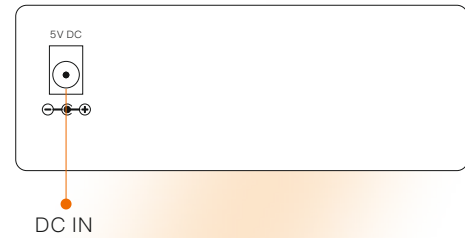

WI-MC101G

Dimensions (mm)

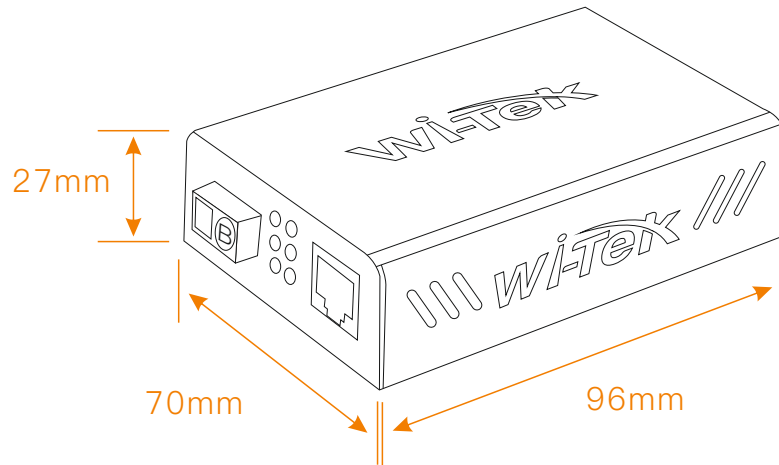

Front Panel

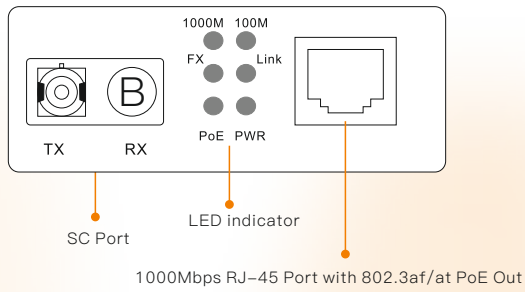

Rear Panel

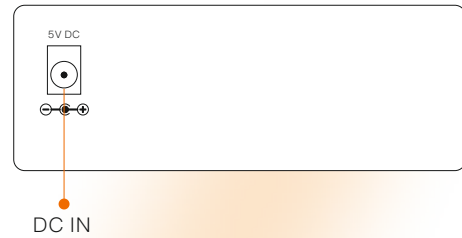

WI-MC111G

Dimensions (mm)

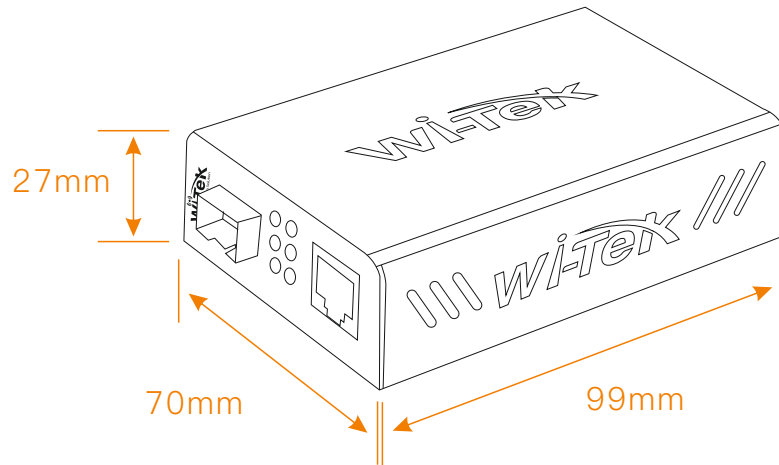

Front Panel

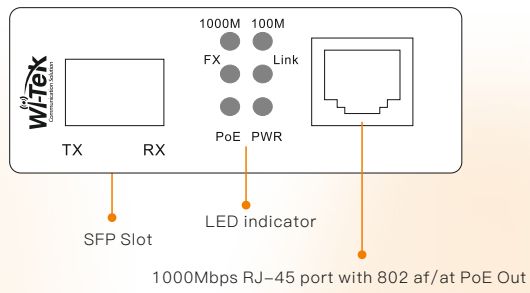

Rear Panel

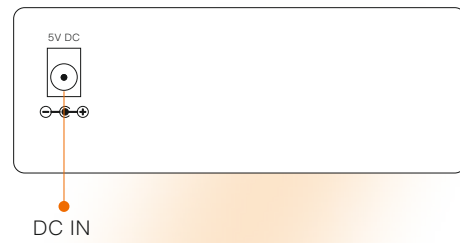

WI-MC111GP

Dimensions (mm)

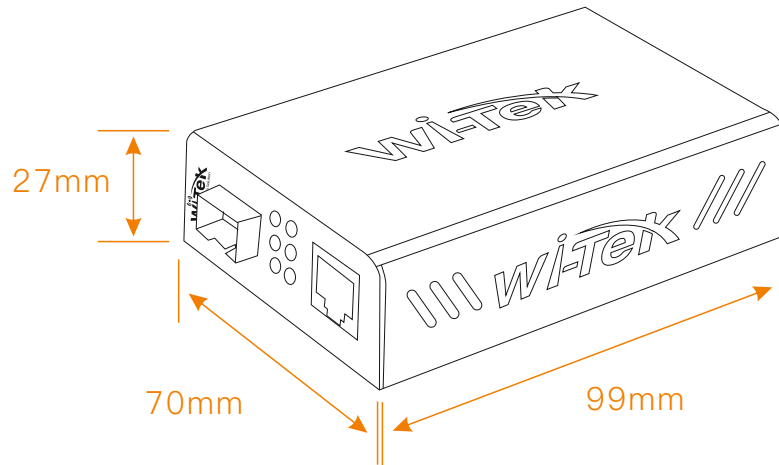

Front Panel

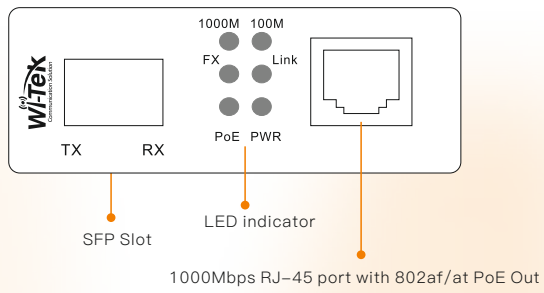

Rear Panel

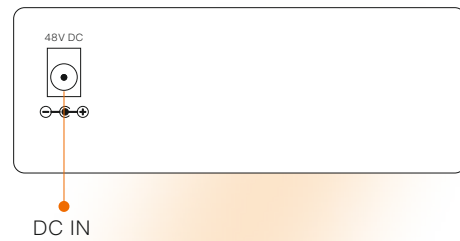

WI-MC111GP-O

Dimensions (mm)

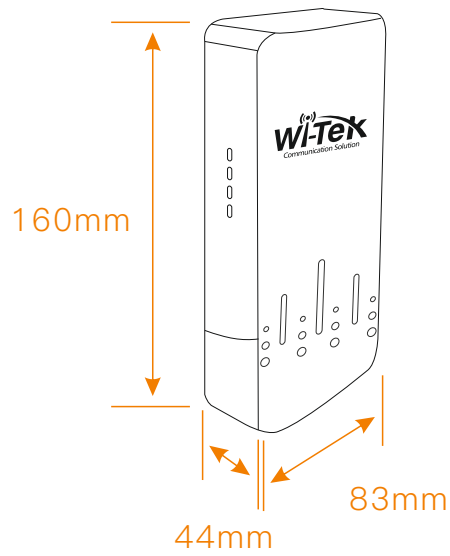

Front Panel

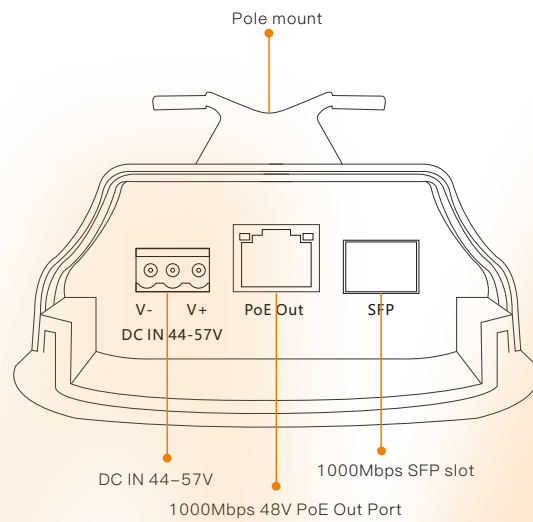

Package Contents

Welcome to order our products. After purchasing, you will receive:

Package Content (For WI-MC101M, WI-MC103G, WI-MC101G)

Items	Quantity
Media Converter	2 pcs
Power Adapter	2 pcs
Power Adapter	1 pcs

Package Content (For WI-MC111G, WI-MC111GP)

Items	Quantity
Media Converter	1 pcs
Power Adapter	1 pcs
Quick Installation Guide	1 pcs

Package Content (For WI-MC111GP-O)

Items	Quantity
Media Converter	1 pcs
Quick Installation Guide	1 pcs
Plastic Strap	1 pcs



Wireless-Tek Technology Limited
 Address: Building 3, Units 1801-1807, 1812, Huaqiang Era Plaza, Tangwei Community, Fuhai Street, Bao'an District, Shenzhen City, Guangdong Province, China.
 Website: www.wireless-tek.com
 Tel: 86-0755-32811290
 Email: sales@wireless-tek.com
 Technical Support: tech@wireless-tek.com



Technical Support



Cloud Management



Company Website